

The Crystal Structure of Methylene Blue Pentahydrate

BY HAROLD E. MARR III* AND JAMES M. STEWART

Department of Chemistry, University of Maryland, College Park, Maryland 20740, U.S.A.

AND M. F. CHIU

The Atlas Computer Laboratory, Chilton, Didcot, Berkshire, England

(Received 13 April 1972; accepted 18 November 1972)

The crystal structure of methylene blue, 3,7-bisdimethylaminophenazothionium chloride pentahydrate, was determined by direct methods from single-crystal X-ray diffraction data. $C_{16}H_{18}N_3S^+Cl^- \cdot 5H_2O$ crystallizes in the monoclinic system, space group $P2_1/c$, with $a=9.646$ (9), $b=31.106$ (17), $c=6.992$ (2) Å, $\beta=96.70$ (6). The structure was refined by full-matrix least-squares calculations to $R=0.057$. The dye molecules are essentially planar, with twenty molecules of water of hydration per unit cell, forming an interesting hydrogen-bonding network through the lattice. Positions for C, N, S, O, and Cl atoms were determined from Fourier electron-density maps. Hydrogen atom positions were refined from a clathrate ice-like model.

Introduction

The molecular structure of methylene blue has been investigated in the liquid and crystalline states by numerous physical methods. X-ray diffraction studies have been attempted, but the successful refinement of the crystal structure determination has not been reported. There has also been considerable reference in the literature to the proper placement of the formal charge on the cation, $C_{16}H_{18}N_3S^+$. An X-ray diffraction study (Zhadanov, Zvonkova & Vorontsova, 1956) led to the conclusion that the sulfur atom of the methylene blue cation is closest to the chloride ion and this is possibly explained by placement of the positive charge on the sulfur as in structure (I). An observation that the chloride ion is closest to the methyl groups (Taylor, 1935) would suggest distribution of the charge between the terminal amine groups resulting from contributions to the stable structure by forms represented as structure (II). A recent report stated, from observations of X-ray line shifts of sulfur, that structure (I) is not a probable representation (Takahashi, Yabe & Sato, 1969).

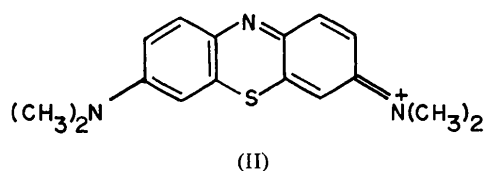
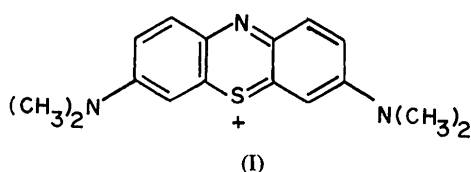

* Present address: U.S. Bureau of Mines, College Park Metallurgy Research Center, College Park, Maryland 20740, U.S.A.

A preferable description of the charge distribution is that the charge is delocalized over the whole π -orbital system of this molecule rather than being extremely localized. This belief is based upon the application of an LCAO MO calculation in contrast to the valence bond structures (I) and (II).

A study of hydrate crystals of a clathrate type found in several biologically active compounds has given rise to a molecular theory of general anesthesia (Pauling, 1961). The existence of the extensive hydrogen-bonding network in methylene blue suggested that the structure might have additional interest beyond the antimalarial studies. In the investigations of crystalline methylene blue, however, it was the instability of the hydration level (Warwicker, 1955), as well as the propensity for twinning, that probably frustrated previous attempts at the crystal structure determination. The present study was initiated in cooperation with the Walter Reed Army Institute of Research to determine the crystal structures of compounds exhibiting antimalarial activity and to clarify the molecular structure of this compound.

Crystal data

$C_{16}H_{18}N_3S^+Cl^- \cdot 5H_2O$, F. W. 410,
Monoclinic, $P2_1/c$
At 21°C:
 $a=9.646$ (9), $b=31.106$ (17), $c=6.992$ (2) Å
 $\beta=96.70$ (6)°, $Z=4$, $V=2083$ Å³
 $D_m=1.31$ $D_x=1.307$ g cm⁻³
Nb filtered Mo radiation
 $F(000)=216$.

Experimental

Large tabular crystals were obtained for single-crystal studies. The opaque greenish-blue plates were easily cleaved along the axes defined by the crystal edges. Several crystals, each approximately $0.5 \times 0.04 \times 0.3$ mm, were mounted on pin mountings and examined on

CRYSTAL STRUCTURE OF METHYLENE BLUE PENTAHYDRATE

Table 1. Observed and calculated structure factors

The columns are k, 10F_o, and 10F_c. Unobserved data are marked with an asterisk (*).

Table with multiple columns representing Miller indices (h, k, l) and structure factor values (F_o, F_c). The table is organized into sections based on the k value (0, 1, 2, 3, 4, 5, 6, 7, 8, 9, 10, 11, 12, 13, 14, 15, 16, 17, 18, 19, 20). Each section contains rows for different l values, with columns for h, 10F_o, and 10F_c. Asterisks indicate unobserved data points.

the optical goniometer. It was assumed that no coating was necessary, as the crystals seemed stable in air over a period of several weeks under conditions of high relative humidity. The hydration, and consequently the stability of the crystals, is dependent on the ambient humidity and during the course of this project, the humidity was maintained at a level above 60% r.h.

Initial values of cell parameters were determined from rotation photographs and zero-level Weissenberg photographs from a Weissenberg camera using Cu $K\alpha$ radiation. The absence of $h0l$ reflections with l odd and $0k0$ reflections with k odd, indicated the space group $P2_1/c$.

Settings were calculated for methylene blue for use on the General Electric XRD-6 diffractometer equipped with a molybdenum target tube and card automated Eulerian cradle.

Intensity measurements were made on all the reflections by scanning over 2θ at 2.0° per min and integrating over the scan range. Backgrounds were measured for twenty sec at each end of the 2θ scan range by a stationary count method. Four reflections were chosen as standards and were repeatedly measured throughout the course of the collection of data. Data was automatically recorded on punched cards and subsequently processed with the use of the X-ray crystallographic computing system *X-RAY67* (1967). 5594 total observations yielded an averaged asymmetric set consisting of 1506 independent observed reflections and 1018 reflections coded unobserved (Table 1). A unique set of reflections from the asymmetric unit was selected, the scan intensities were adjusted for background and $1/L_p$ corrections were applied. No absorption corrections were applied.

In the solution of the structure of methylene blue, the preliminary computations were made with all weights equal. A weighting scheme was later applied in which the weighting factor = Q_1/J , where J is the maximum of three functions: (1) standard deviation from counting statistics; (2) $Q_2 \cdot F_{\text{obs}}$; (3) Q_3 . For methylene blue, the following values were used: $Q_1=0.15$, $Q_2=0.01$, $Q_3=0.15$.

The scattering factors for C, N, O, S and Cl^- were taken from *International Tables for X-ray Crystallography* (1962) for C, N, O, S, Cl^- . Hydrogen scattering factors were taken from Stewart, Davidson, & Simpson (1965).

292 phases with high E values were generated from the $\bar{1}02$, 331 , and $\bar{1}12$ reflections. This process was carried out with the *X-RAY67* programs *DATFIX*, *SIGMA2* and *PHASE*. The signed values of these 292 quasi-normalized structure factors were used to generate a probability electron-density map with the E values as coefficients in the Fourier transform equations.

From the E map, the basic covalent bonded unit of one sulfur, three nitrogen and sixteen carbon atoms was found. Other peaks, presumably chlorine or oxygen, were noted. Structure factors calculated from the coordinates of these 20 atoms resulted in an R index of 0.48.

At this state of refinement a comparison of the calculated and observed structure factors showed that the $0kl$ reflections consistently calculated higher structure factors than observed. Reference to the original observations of scan and background intensities showed that the peaks were badly overlapping for this particular crystal mounting. Certain other reflections which showed large differences between calculated and observed structure factors were noted to have large dif-

Table 2. Atomic positions and thermal parameters ($\times 10^4$)

	x	y	z	U_{11}	U_{22}	U_{33}	U_{12}	U_{13}	U_{23}
S(5)	7291 (1)	2757 (1)	7740 (2)	336 (7)	328 (5)	606 (9)	7 (6)	31 (5)	-10 (7)
N(10)	4035 (4)	2827 (1)	6970 (6)	438 (23)	352 (25)	451 (27)	-16 (18)	51 (18)	-41 (21)
N(11)	6143 (4)	1177 (1)	7504 (6)	500 (27)	308 (25)	629 (33)	28 (18)	89 (21)	17 (20)
N(12)	6875 (4)	4371 (1)	7723 (6)	508 (27)	333 (25)	613 (33)	-31 (18)	-2 (21)	24 (21)
C(1)	3716 (5)	2075 (2)	6881 (8)	384 (28)	544 (34)	557 (39)	-7 (22)	21 (25)	2 (29)
C(2)	4197 (5)	1668 (2)	6979 (7)	518 (31)	401 (30)	435 (37)	-63 (24)	68 (25)	0 (26)
C(3)	5651 (5)	1581 (2)	7367 (7)	458 (30)	392 (30)	326 (32)	-16 (21)	59 (23)	9 (25)
C(4)	6559 (5)	1934 (2)	7586 (7)	348 (28)	446 (30)	437 (36)	-34 (22)	38 (23)	32 (25)
C(4a)	6073 (5)	2343 (2)	7461 (7)	427 (28)	367 (30)	321 (32)	12 (19)	36 (22)	-45 (24)
C(10a)	4619 (5)	2437 (2)	7102 (7)	399 (28)	377 (30)	373 (36)	-21 (21)	42 (24)	-63 (25)
C(5a)	6284 (5)	3215 (2)	7529 (7)	435 (30)	426 (34)	355 (33)	3 (22)	18 (22)	7 (26)
C(6)	6943 (5)	3597 (2)	7716 (7)	400 (30)	416 (30)	503 (35)	46 (22)	53 (24)	-7 (27)
C(7)	6215 (4)	3995 (2)	7556 (7)	378 (28)	450 (30)	406 (35)	18 (22)	-5 (23)	22 (25)
C(8)	4711 (5)	3967 (2)	7199 (8)	443 (30)	348 (30)	600 (41)	21 (24)	122 (26)	-28 (28)
C(9)	4063 (5)	3586 (2)	7000 (8)	336 (29)	450 (34)	606 (39)	34 (22)	66 (24)	-48 (29)
C(9a)	4787 (4)	3189 (2)	7155 (7)	333 (27)	455 (30)	476 (37)	48 (22)	81 (20)	-7 (28)
C(13)	5243 (6)	804 (2)	7314 (11)	616 (36)	377 (34)	779 (45)	13 (25)	53 (30)	-91 (32)
C(14)	7625 (6)	1096 (2)	7864 (11)	545 (36)	455 (34)	861 (49)	113 (25)	106 (31)	54 (33)
C(15)	8387 (6)	4409 (2)	8944 (11)	506 (34)	549 (34)	971 (53)	-61 (27)	-25 (31)	0 (36)
C(16)	6134 (7)	4783 (2)	7589 (11)	663 (38)	377 (35)	756 (48)	-27 (25)	-28 (31)	-12 (31)
Cl(1)	2186 (2)	4867 (1)	7359 (3)	650 (9)	583 (9)	977 (13)	30 (7)	-5 (8)	-30 (10)
O(1)	516 (5)	482 (2)	8419 (8)	737 (28)	950 (34)	1074 (39)	-110 (74)	-6 (24)	228 (30)
O(2)	11 (4)	2090 (2)	7658 (7)	664 (25)	745 (29)	922 (35)	-75 (21)	134 (22)	43 (25)
O(3)	1777 (4)	835 (1)	5453 (8)	730 (26)	700 (29)	1035 (38)	-89 (22)	114 (23)	99 (26)
O(4)	1005 (4)	2905 (1)	6550 (7)	526 (23)	705 (29)	948 (33)	15 (18)	109 (21)	-237 (24)
O(5)	295 (4)	3425 (1)	9503 (8)	716 (26)	661 (29)	998 (33)	21 (21)	103 (23)	-2 (25)

Table 2 (cont.)

Hydrogen atom position and thermal parameters ($\times 10^4$)

	<i>x</i>	<i>y</i>	<i>z</i>	<i>U</i>
H(1)	2742 (44)	2147 (13)	6764 (60)	489
H(2)	3527 (40)	1422 (13)	6800 (59)	444
H(3)	7508 (40)	1903 (13)	7894 (57)	412
H(4)	7909 (40)	3572 (13)	7923 (56)	430
H(5)	4156 (40)	4224 (14)	7354 (60)	469
H(6)	3108 (43)	3550 (13)	6816 (58)	466
H(7)	4450 (47)	776 (14)	7872 (71)	557
H(8)	5742 (42)	523 (16)	7397 (63)	557
H(9)	4625 (47)	860 (14)	6261 (71)	557
H(10)	7814 (42)	765 (16)	7640 (67)	616
H(11)	8103 (44)	1226 (15)	6600 (60)	616
H(12)	8245 (46)	1216 (14)	8922 (68)	616
H(13)	8710 (46)	4380 (16)	9243 (74)	650
H(14)	8937 (47)	4217 (16)	7538 (73)	650
H(15)	8680 (43)	4756 (16)	7645 (70)	650
H(16)	6348 (43)	4887 (15)	6485 (72)	541
H(17)	5021 (47)	4799 (13)	7375 (63)	541
H(18)	6604 (45)	4954 (15)	8141 (73)	541
H(19)	1197 (55)	414 (17)	9696 (85)	916
H(20)	- 213 (55)	302 (17)	8261 (79)	916
H(21)	165 (47)	2020 (16)	9073 (81)	762
H(22)	261 (49)	2368 (17)	7396 (75)	762
H(23)	1357 (49)	712 (17)	6569 (78)	801
H(24)	1664 (47)	647 (17)	3882 (81)	801
H(25)	591 (46)	3020 (16)	7617 (77)	706
H(26)	2016 (53)	2884 (14)	6740 (70)	706
H(27)	744 (49)	3670 (17)	9798 (74)	789
H(28)	250 (46)	3318 (16)	1135 (81)	789

ferences between the two measurements of background. All such reflections were systematically eliminated.

A difference synthesis $|F_o - F_c|$ brought out several strong peaks, two of which were at the positions predicted for the possible sites of the chlorine atom (Zhdanov, Zvonkova & Vorontsova, 1956). Chlorine atoms, each with one half-site occupancy, were placed in these positions and three cycles of full-matrix least-squares were computed on positional parameters and isotropic temperature factors. The *R* value dropped to 0.38 but, more significantly, the temperature factor of one of the chlorine atoms became negative, indicating that more electron-density than that represented by $\frac{1}{2}$ a chlorine atom was needed at that site. The temperature factor for the atom at the other site was not unreasonable, however, and it was clear that this site was occupied, presumably by an oxygen atom of a water molecule.

A second difference map indicated possible site occupancy at several other positions. Once the chloride ions were correctly placed and the oxygen atoms at five sites included in the model, isotropic least-squares refinement reduced the *R* to 0.14.

Since one of the more interesting aspects of this structure, from a crystallographic standpoint, was the hydrogen-bonding network, a considerable effort was made to locate the hydrogen atoms on the water mole-

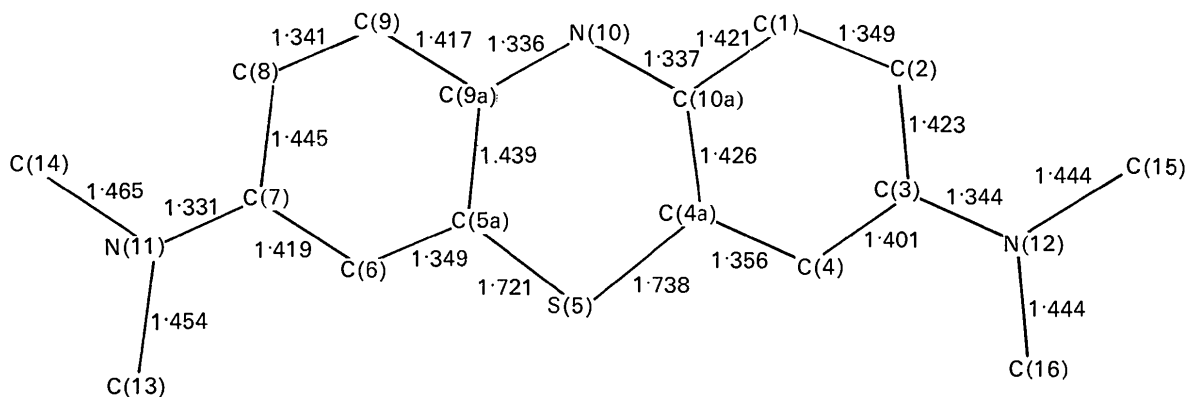

Fig. 1. Bond lengths for methylene blue. E.s.d.'s are 0.007 Å.

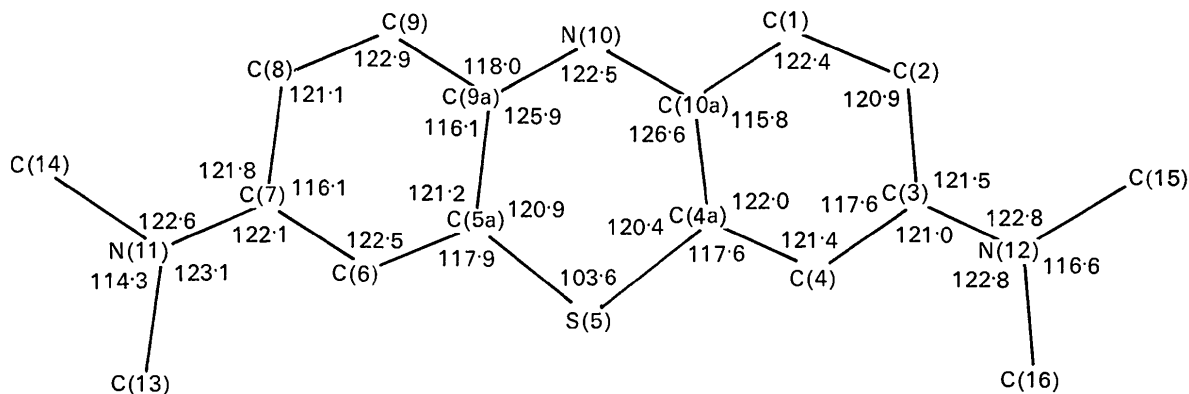

Fig. 2. Bond angles for methylene blue. E.s.d.'s are 0.5°.

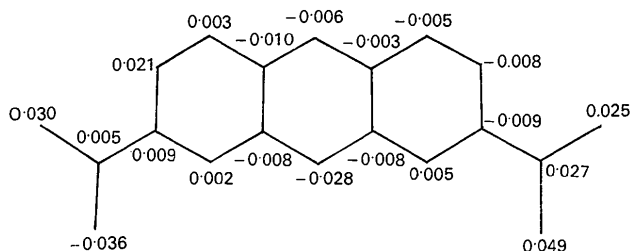

Fig. 3. Distances (Å) from least squares plane.

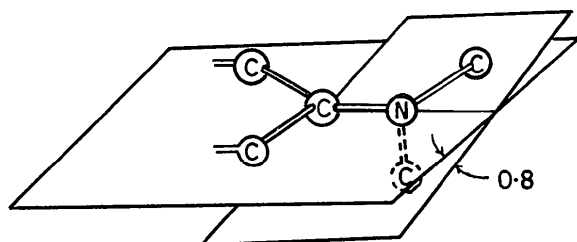

Fig. 4. Intersection of planes showing rotation of dimethylamine group around C-N bond.

cules. A tetrahedrally linked framework of hydrogen bonds was expected and a possible model was calculated which yielded hydrogen-oxygen bond distances of 0.96 Å. The proton positions were initially placed on the oxygen-oxygen center lines with the angles determined by the tetrahedral packing of the oxygen, nitrogen, and chlorine atoms. Then the hydrogen coordinates were subjected to three cycles of full matrix least-squares refinement. The final *R* value calculated for the structure was 0.057.

Isotropic temperature factors for the hydrogen atoms were assigned from the final isotropic temperature factor of the atom which each hydrogen was bonded.

The anisotropic temperature factors were defined by the following equation:

$$T = \exp \left[- (U_{11}h^2a^{*2} + U_{22}k^2b^{*2} + U_{33}l^2c^{*2} + U_{12}hka^*b^* + U_{13}hla^*c^* + U_{23}klb^*c^*)2\pi^2 \right].$$

The final values for the atomic positional parameters and thermal parameters are shown in Table 2.

A simple Hückel MO π -electron calculation was performed to obtain eigenvalues, eigenvectors and π -bond orders for this molecule. The Hückel h_X and k_{XY} parameters for sulfur ($h_S = 1.25$, $k_{CS} = 0.57$) and nitrogen ($h_N = 0.50$, $h_{CN} = 0.80$, $h_N = 1.50$, $h_{C-N} = 0.70$) were obtained from Lamotte & Berthier (1966) and Streitwieser (1961, p. 135) respectively. The methyl groups were described by the 'conjugation model' employing the parameters of Lazdins & Karplus (1965) (N-X-Y, $h_X = -0.10$, $k_{NX} = 0.70$, $h_Y = 0.50$, $k_{XY} = 2.50$). For the purposes of this calculation the molecule was forced to have $2/m$ (C_{2v}) symmetry. LCAO MO calculated bond lengths were obtained from the Hückel bond orders using Coulson's (1939) formula with Streitwieser's parameters (1961, p. 167).

Discussion

The bond lengths and angles given by the X-ray data are shown in Figs. 1 and 2, and Table 3 gives the C-H bond lengths. Fig. 6 shows the location of the chloride ions relative to the dye and water molecules. It should be noted that the shortest Cl-N distance in each case is to the methyl substituted nitrogen and not to the intratracyclic N or S atoms as has been reported.

Table 3. Carbon-hydrogen bond lengths

C(1)—H(1)	0.96 (4) Å	C(9)—H(6)	0.92 (4) Å
C(2)—H(2)	1.00 (4)	C(8)—H(5)	0.98 (4)
C(4)—H(3)	0.92 (5)	C(6)—H(4)	0.93 (4)
C(13)—H(7)	0.90 (5)	C(15)—H(13)	0.87 (5)
C(13)—H(8)	1.00 (5)	C(15)—H(14)	0.90 (5)
C(13)—H(9)	0.91 (5)	C(15)—H(15)	1.16 (5)
C(14)—H(10)	1.06 (5)	C(16)—H(16)	0.88 (5)
C(14)—H(11)	1.12 (5)	C(16)—H(17)	1.07 (5)
C(14)—H(12)	0.97 (4)	C(16)—H(18)	0.77 (5)

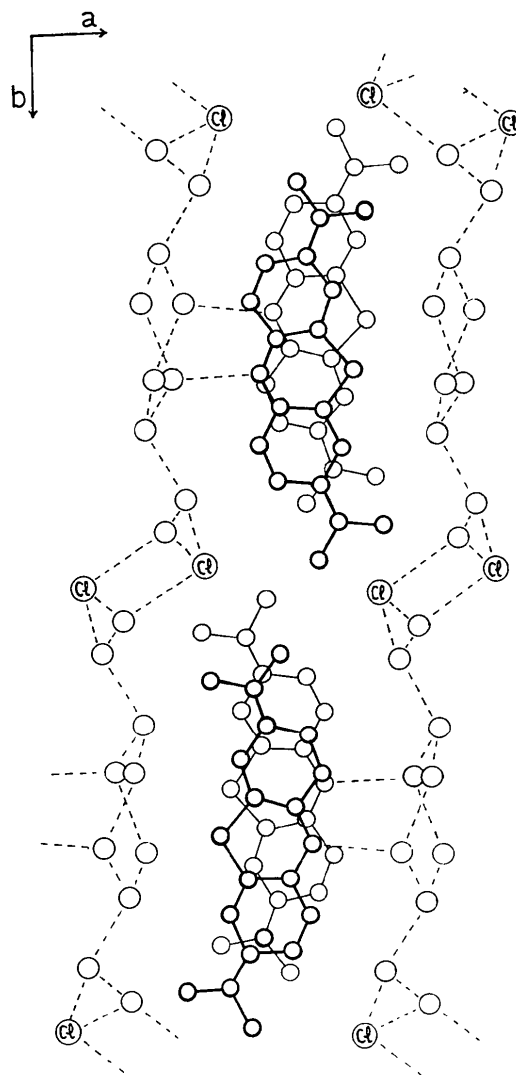
Fig. 5. Methylene blue viewed down the c^* axis of the unit cell.

The equation which describes the plane of the molecule was calculated to be: $-1.721x - 0.150y + 6.978z = 4.133$. Fig. 3 shows the molecule, and the figure in parentheses beside each atom is the distance in Å to the plane. The methyl groups were not included in the least-squares determination of the plane, but the distances from the plane were calculated. The average estimated error in each position parameter for the heavy atoms is approximately 0.005 Å, the accumulated error for three dimensions being about 0.009 Å. If the molecule were truly planar, the standard deviation of the distances of the atoms from the planes would be expected to be of this magnitude. In fact, the standard deviation is 0.013 Å.

Therefore, by a test of mathematical statistical significance, the molecule would be considered nonplanar. However, for most chemical purposes and for crystal packing considerations, the structure is essentially planar. The lack of planarity is probably due to a slight puckering of the molecule at the sulfur and nitrogen atoms which bridge the two benzene rings.

The methyl groups were not included in the fitting of the planes and an examination of the carbon atom positions yields some information about the contribution of the amine nitrogens to the π systems. The distance from the phenothiazine plane to C(15) is 0.049 Å and to C(16) is 0.025 Å, both having a positive sense relative to the origin, indicating a rotation and a bend. Atoms C(13) and C(14) are -0.036 and 0.030 Å from the plane, indicating a rotation around the bond between the nitrogen and the phenothiazine nucleus. In order to calculate the rotation around these bonds, the planes defined by the nitrogen atoms and three carbon atoms were determined. The rotations were calculated to be 0.8 and 1.1° for N(12) and N(11) respectively (Fig. 4). The fact that the methyl carbons were very close to the plane of the molecule indicated that there was a high degree of π bonding involving the amine nitrogen atoms. The contribution of structure (II) as the appropriate representation of methylene blue, with the formal charge placed on the nitrogen of the amine group, is supported by the concept of π bonding involving the amine group.

The pattern of hydrogen bonding involving the water molecules in crystalline methylene blue is shown in Figs. 5 and 6. From the tetrahedral model of the hydrogen atoms, which was constructed from peaks on an electron-density difference map, the hydrogen atomic coordinates were refined by three cycles of least-squares refinement. This type of refinement was near the limit of sensitivity of the X-ray data, but the reliability of the data was strengthened by the observation that the bond lengths and angles involving hydrogen atoms remained reasonable after three cycles of refinement. Each water molecule formed two hydrogen bonds which ranged between 1.69 and 2.33 Å. Although the possibility existed that oxygen–oxygen distances of 2.77 Å were not hydrogen bonds but simple van der Waals contacts with random packing, the general ordering of the hydrogen

atoms along the oxygen–oxygen centerlines seemed to preclude this possibility. The distances and angles which describe the water molecules and contact distances in the hydrogen bonding network are shown in Table 4.

The methylene blue cations are stacked in layers perpendicular to the c^* axis. The unit cell as viewed down this axis is represented in Fig. 5. A hydrogen-bonding network is formed by the water molecules and chloride ions. This network exists as a narrow layer which is roughly perpendicular to the planes formed by the cations, occupying a region midway between units in adjacent cells. A view of the hydrogen-bonding network down the a^* axis is shown in Fig. 6. In order to show the methylene blue structure, the cell has been rotated 20° about the b^* axis.

The bond lengths and angles calculated for methylene blue are comparable with values observed in sim-

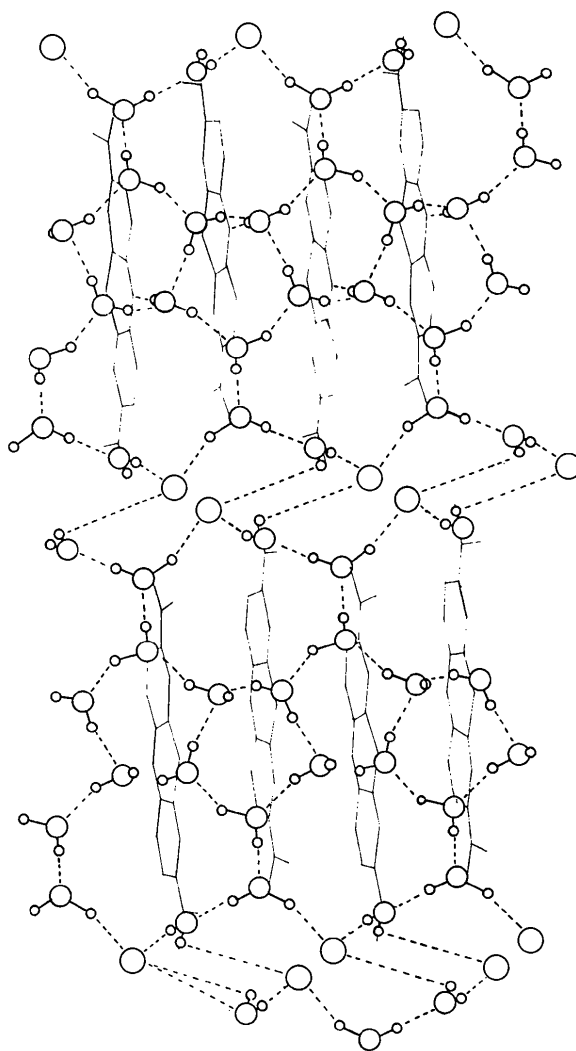
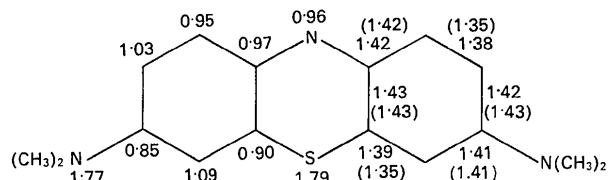

Fig. 6. Hydrogen bonding. Two unit cells of methylene blue viewed approximately down the a^* axis (rotated 20° about b^*).

Table 4. Bond lengths and bond angles for water molecules after refinement

O(1)–H(19)	1.025 (5) Å	O(1)–H(20)	0.90 (5) Å
O(2)–H(21)	1.01 (5)	O(2)–H(22)	0.93 (5)
O(3)–H(23)	1.24 (5)	O(3)–H(24)	1.00 (5)
O(4)–H(25)	0.96 (5)	O(4)–H(26)	0.97 (5)
O(5)–H(27)	0.89 (5)	O(5)–H(28)	1.20 (5)
H–O(1)–H	113 (5)°		
H–O(2)–H	113 (5)		
H–O(3)–H	121 (5)		
H–O(4)–H	115 (5)		
H–O(5)–H	95 (5)		
Hydrogen bonds			
O(1)···H	1.76 (5) Å		
O(2)···H	1.69 (5)		
O(3)···H	1.86 (5)		
O(4)···H	1.84 (5)		
O(5)···H	1.87 (5)		
Oxygen–oxygen contacts			
O(1)–O(3)	2.76 (1) Å		
O(2)–O(4)	2.78 (1)		
O(2)–O(5)	2.77 (1)		
O(3)–O(5)	2.75 (1)		
O(4)–O(5)	2.77 (1)		
Chlorine–oxygen contacts			
Cl(1)–O(1)	3.22 (1) Å		
Cl(1)–O(3)	3.18 (1)		
Cl(1')–O(1)	3.15 (1)		
Nitrogen–oxygen contact			
N(10)–O(4)	2.92 (1) Å		

ilar structures. The calculated bond lengths and bond angles of the dye molecule are represented in Figs. 1 and 2 with estimated standard deviations in parentheses. Of the two valence bond representations of the charge distribution that have been considered, the bond lengths for methylene blue determined by the present study indicate that structure (II) is the more appropriate representation, the most prominent indication being the pronounced shortening of bonds C(1)–C(2) and C(4)–C(4a) compared with the other carbon–carbon bonds. If structure (I) were significant, bond C(3)–C(4)

Fig. 7. Bond lengths and π -electron charges from molecular orbital calculations.

would tend to be shorter than the normal benzene C–C bond of 1.397 Å. Bonds C(3)–C(4) and C(6)–C(7) are slightly longer than 1.397 Å, indicating a little less double-bond character than would be expected if (I) were a contributing structure. The two structures are meant to identify the two types of structures with different placements of the formal charges. There are several equivalent forms for each representation, resulting in C_{2v} symmetry of the resonance hybrid.

The conclusions drawn from the molecular-orbital description is different from that implied by the isolated valence bond structures (I) and (II). The averaged diffraction-derived C–C bond lengths are compared with those obtained from the HMO calculations in Fig. 7. As the values of the heteroatom parameters are typical of those used in a variety of other applications, our results suggest that the charge distribution around the dye molecule in the crystal is not distortingly anisotropic. The similarity of calculated π -electron charges on the centers of interest ($S, P^\pi = 1.79$; N [exocyclic] $P^\pi = 1.77$) though only a guide, suggest that the positive charge of the molecule is fairly evenly distributed over all three atoms. The diffraction evidence indicates a preponderance of positive attraction on the exocyclic nitrogen in agreement with but not strongly predicted by the HMO calculation. The π -electron charges derived from this calculation are shown in italics in Fig 7.

References

- COULSON, C. A., (1939). *Proc. Roy. Soc. A* **169**, 413–428.
International Tables for X-ray Crystallography (1962). Vol. III. Birmingham: Kynoch Press.
LAMOTTE, B. & BERTHIER, G., (1966). *J. Chim. Phys.* **63**, 369–378.
LAZDINS, D. & KARPLUS, M., (1965). *J. Amer. Chem. Soc.* **87**, 920–921.
PAULING, L. (1961). *Science*, **134**, 15–21.
STEWART, R. F., DAVIDSON, E. R. & SIMPSON, W. T. (1965). *J. Chem. Phys.* **42**, 3175–3187.
STREITWIESER, A. (1961). *Molecular Orbital Theory for Organic Chemists*. New York: John Wiley.
TAKAHASHI, Y., YABE, K. & SATO, T. (1969). *Bull. Chem. Soc. Japan*, **42**, 2707–2708.
TAYLOR, W. H. (1935). *Z. Kristallogr.* **91**, 450–465.
WARWICKER, J. O. (1955). *J. Chem. Soc.* p. 2531.
X-RAY 67 (1967). *Program System for X-ray Crystallography*. Computer Science Center, Univ. of Maryland Technical Report 67–58, 181 pages.
ZHDANOV, G. S., ZVONKOVA, Z. V. & VORONTOVA, L. G. (1956). *Sov. Phys. Crystallogr.* **1**, 44–48.